

TPM-04SH-DL USER MANUAL



- * Measures up to voltage harmonics 31st.
- * Measures up to current harmonics 31st.
- * Supports 3P4W connections.
- * RS485 Modbus RTU
- * 53 x 31mm Custom Design Glass LCD
- * It shows the powers of each phase (P1, P2, P3).
- * It shows the reactive powers of each phase (Q1, Q2, Q3 inductive and capacitive).
- * It shows the apparent powers of each phase (S1, S2, S3).
- * It shows power factors (PF) and $\cos\phi$ values of each phases.
- * It shows the min., max. and ave. values of the phase-to-phase and phase-neutral voltages.
- * It shows the values of each phase (I1, I2, I3).
- * It shows total import and export active (ΣkWh) energies..
- * It shows total inductive and capacitive reactive (ΣkWh_{arh}) energies.
- * Digital Input.
- * Relay output (adjustable).
- * It shows voltage and current irregularity.
- * It show demands. (Current, Active/Reactive/Apparent Power)
- * You can delete energies and demands.
- * The menu is password protected.

1 - Connection Diagrams:

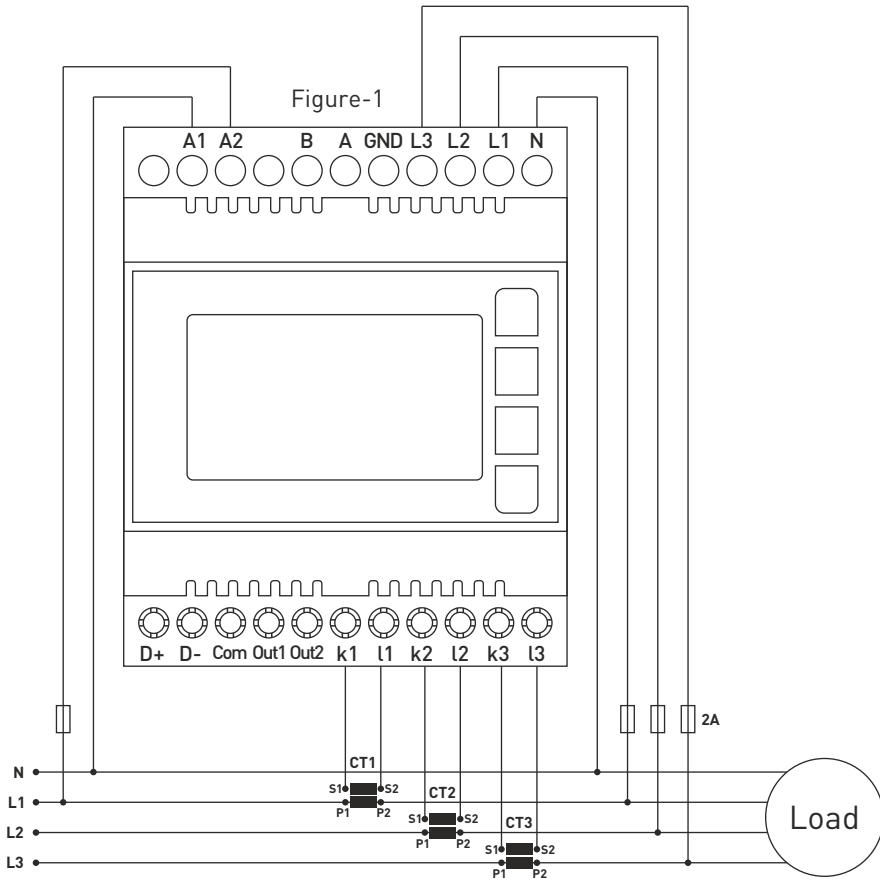

Figure-1: 3P4W connection type: 3 phase current and 3 phase voltage and neutral.

2 - Matters to be considered in current transformer selection and connection

- Note that the value of current transformer is higher than the maximum current drawn from the system.
- It is advisable that the class of the current transformer (it can be written class, klas, cl, kl) is 0.5.
- To avoid the complexity when connecting the current transformer output terminal use different colour cables or give cable numbers.
- Please spread the cables which are connected to current transformer output terminal from remote high voltage lines.
- Please fix current transformers to bara, cable or rail to avoid rattling.

3 - Warnings:

- Please use the device properly according to our directions.
- Please protect LCD screen from sun light.
- Please take 5 cm. space behind the device after the device installation.
- Please not use device in the damp board.
- Please add a key or circuit breaker to assembly.
- Please keep key or circuit breaker close the device or in an easily accessible location by the operator.
- There should be no electricity in the connection cables when assembling device.
- There should be used shielded or twisted cord cable at the non-network-connected input and output. lines. These cables should not be passed near the high power lines and the device.
- Assembling and electrical connections must be done by technical staff according to instruction manuel.
- The feed cables should be suitable for IEC 60227 or IEC 60245 requirements.

4 - Device Maintenance :

Turn off energy of the device and disconnect from connections. Clean the device body by using slightly moist or dry cloth. Do not use conductor or other chemical as a cleaning agent matter which is harmful to device. Make connections after the cleaning of device and give energy to device and make sure that device works properly.

5 - General:

TPM-04SH-DL Energy analyzers measures load or voltage, current, $\cos\phi$, active power, reactive power, minimum and maximum values of the load and also measures demands. This analyzer measures current harmonics and voltage harmonics up to 31. harmonics.

6 - First Operation of the Device:

Please read the warnings before powering the device. Make connections of the device according to the connection scheme. When the device is first powered up figure-3 displayed on the screen. Firstly enter the current transformer ratio from the settings menu and if the voltage transformer medium voltage is being measured), enter the voltage transformer ratios.

7- Introduction of Screen:

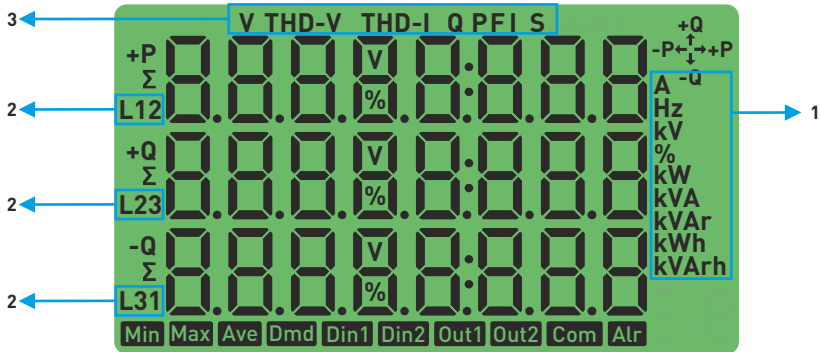

Figure-2

1 - Indicates the unit of the value.

2 - Indicates which phase the value belongs to .

3 - Indicates displayed values. V-voltage, I-current, F-frequency, S-apparent power, P-active power, PF-power factor, FI-cosine phi, THD-I-total current harmonics, THD-V- total voltage harmonics, Q- reactive power.

$\rightarrow +P$ Specified that the indicated active energies are imported.

$\leftarrow -P$ Specified that the indicated active energies are exported.

$\uparrow +Q$ Specified that the indicated reactive energies are inductive.

$\downarrow -Q$ Specified that the indicated reactive energies are capacitive.

Min Indicates that the values shown are minimum.
(Period: 2 seconds.)

Max Indicates that the values shown are maximum.
(Period: 2 seconds.)

Ave Indicates that the values shown are average.
(Period: 5 minutes.)

Dmd Indicates that the values shown are demand.
(Period: 15 minutes.)

Din1 Din1: There is voltage(1).

Din1: There is no voltage(0).

Out1 Out1: Relay 1 is pulled.
(Short circuit)

Out1: Relay 1 is released.
(Spen circuit)

Out2 Out2: Relay 2 is pulled.
(Short circuit)

Out2: Relay 2 is released.
(Open circuit)

+P Σ Total active energy.

+Q Σ Total inductive reactive energy.

-Q Σ Total capacitive reactive energy.

8- Introduction of Buttons:



ESC: Press this button while in menu to exit the menu without saving the values. When this key is pressed while not in the menu, the screen always shows figure-3.



SET: This button enters menu/parameter. It records the changes of parameters and remove from parameter.



DOWN: This button enables to fast progress between the values that are measured out of menu. Changes the value while inside the parameters in the menu.



RIGHT: This button allows to progress by displaying the measured values outside the menu together with the details. It allows navigation between parameters when pressed in menu. In the parameter, it allows to transition between steps and parameters.

9 - Progress On Screen Information:



Figure-3



Figure-4



Figure-5



Figure-6

Figure-3: Shows phase-neutral voltage. When you press right button, the figure-4 appears on the screen.

Figure-4: Shows minimum(Min) voltage values of phase-neutral voltage. When you press right button, the figure-5 appears on the screen.

Figure-5: Shows maximum(Max) voltage values of phase-neutral voltage. When you press right button, the figure-6 appears on the screen.

Figure-6: Shows average(Ave) voltage values of phase-neutral voltage. When you press right button, the figure-7 appears on the screen

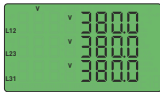

Figure-7



Figure-8



Figure-9



Figure-10

Figure-7: Shows the phase-phase voltage values. When you press right button, the figure-8 appears on the screen.

Figure-8: Shows the minimum(Min) values of the phase-phase voltage. When you press right button, the figure-9 appears on the screen.

Figure-9: Shows the maximum(Max) values of the phase-phase voltage. When you press right button, the figure-10 appears on the screen.

Figure-10: Shows the average(Ave) values of the phase-phase voltage. When you press right button, the figure-11 appears on the screen.



Figure-11



Figure-12

Figure-11: Shows the current values of each phase. When you press the right button, figure-12 appears on the screen.

Figure-12: Shows the current demand(Dmd) values for each phase. When you press the right button, figure-13 appears on the screen.



Figure-13



Figure-14

Figure-13: Shows the active power(P) values for each phase. When you press the right button, figure-14 appears on the screen.

Figure-14: Shows the active power(P) demand(Dmd) values for each phase. When you press the right button, figure-15 appears on the screen.



Figure-15



Figure-16

Figure-15: Shows the reactive power value(Q) values for each phase. When you press the right button, figure-16 appears on the screen.

Figure-16: Shows the active power(Q) demand(Dmd) values for each phase. When you press the right button, figure-17 appears on the screen.



Figure-17



Figure-18

Figure-17: Shows the apparent power(S) values for each phase. When you press the right button, figure-18 appears on the screen.

Figure-18: Shows the apparent power(S) demand(Dmd) values for each phase. When you press the right button, figure-19 appears on the screen.



Figure-19



Figure-20



Figure-21



Figure-22

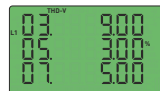

Figure-23

Figure-19: Shows the power factor(PF) values for each phase. When you press the right button, figure-20 appears on the screen.

Figure-20: Shows the cosine phi(FI) values for each phase. When you press the right button, figure-21 appears on the screen.

Figure-21: Shows the frequency(F) values for each phase. When you press the right button, figure-22 appears on the screen.

Figure-22: Shows the total voltage harmonic distortion value (THD-V) values for each phase. When you press the right button, figure-23 appears on the screen.

Figure-23: Voltage harmonics values of up to 31st harmonics are displayed on each screen, with 3 values per screen. When you press the right button, the values of the L2 and L3 phases are displayed on the screen respectively. When you press the right button, figure-24 appears on the screen.



Figure-24



Figure-25



Figure-26

Figure-24: Shows the total current harmonic distortion value(THD-I) values for each phase. When you press the right button, figure-25 appears on the screen.

Figure-25: Current harmonics values of up to 31st harmonics are displayed on each screen, with 3 values per screen. When you press the right button, the values of the L2 and L3 phases are displayed on the screen respectively. When you press the right button, figure-26 appears on the screen.

Figure-26: Shows the total import active, total inductive reactive and total capacitive reactive energy values. When you press the right button, figure-27 appears on the screen.

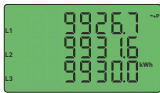

Figure-27



Figure-28



Figure-29

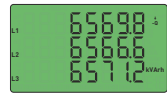

Figure-30

Figure-27: Shows the import active energy values for each phase. When you press the right button, figure-28 appears on the screen.

Figure-28: Shows the export active energy values for each phase. When you press the right button, figure-29 appears on the screen.

Figure-29: Shows the inductive reactive energy values for each phase. When you press the right button, figure-30 appears on the screen.

Figure-30: Shows the capacitive reactive energy values for each phase. When you press the right button, figure-31 appears on the screen.



Figure-31

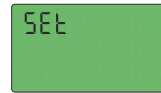

Figure-32

Figure-31: Shows current and voltage irregularity. When you press the right button, figure-32 appears on the screen.

Figure-32: Used to enter the menu to make settings related to the device. When you press the right button again on this screen, the password screen for entering the menu is displayed.

10 - Fast Forwarding of Screen Information:



Figure-3



Figure-7



Figure-11



Figure-13



Figure-32

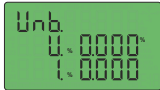

Figure-31

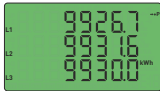

Figure-26



Figure-24



Figure-22



Figure-15



Figure-17



Figure-19



Figure-21

When the device is energised, figure-3 is displayed. When you press the down button, figure-7 is displayed. When you press the down button, figure-11 is displayed. When you press the down button, figure-13 is displayed. When you press the down button, figure-15 is displayed. When you press the down button, figure-17 is displayed. When you press the down button, figure-19 is displayed. When you press the down button, figure-21 is displayed. When you press the down button, figure-22 is displayed. When you press the down button, figure-24 is displayed. When you press the down button, figure-26 is displayed. When you press the down button, figure-31 is displayed. When you press the down button, figure-32 is displayed. When you press the down button, figure-3 is displayed.

Figure-3: Shows the phase-neutral voltage(V) values.

Figure-7: Shows the phase-phase voltage(V) values.

Figure-11: Shows the current (I) values.

Figure-13: Shows the active power(P) values.

Figure-15: Shows the reactive power(Q) values

Figure-17: Shows the apparent power(S) values

Figure-19: Shows the power factor(PF) values

Figure-21: Shows the frequency(F) values

Figure-22: Shows the total voltage harmonic distortion values.

Figure-24: Shows the total current harmonic distortion values.

Figure-26: Shows the total energy (active & reactive) values.

Figure-31: Shows the current and voltage irregularity values.

Figure-32: Used to enter the menu to make settings related to the device.

11 - Menu Structure:



Figure-32



Figure-33

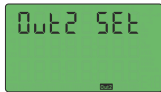

Figure-41

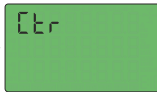

Figure-34

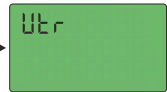

Figure-35

When you press the right button while the figure-32 is on screen, figure-33 password inquiry is displayed on the screen. If a password has been created, enter the password and press the set key.

If password is not created before, when you press set button while password value is "0000", you can enter menu and Figure-34 comes to the screen.

By pressing the right button in the menu, you can scroll through the parameters. Press the set key to set the parameters. Press the Esc key to exit the menu.

Figure-34: It is used to enter the current transformer ratio.

Figure-35: It is used to enter the voltage transformer ratio.

Figure-36: It is used to make communication settings.

Figure-37: It is used to delete Energy and Demand records.

Figure-38: It is used to set the password.

Figure-39: It is used to adjust the backlight light up time.

Figure-40: It is used to assign Relay 1.

Figure-41: It is used to assign Relay 2.



Figure-40

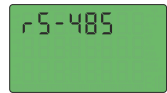

Figure-36

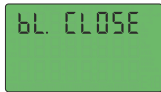

Figure-39



Figure-37

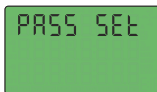

Figure-38



12 - Setting the Current Transformer Ratio:

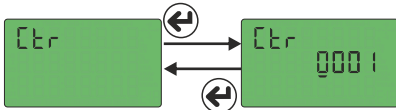

Figure-34

Figure-42

To change the current transformer ratio, press the set button while the figure-34 is on the screen. Figure-42 comes to the screen. Press right button to move between digits. Press the down key to change the value of the digit. You can change the digit value which is the underline. When you press the set button after entering the ratio, the current transformer ratio is recorded and the screen shows figure-34. You can scroll through the parameters

in the menu by pressing the right button or you can exit the menu by pressing the Esc key.

Example: 100 / 5A current transformer ratio (multiplier value) is 20. The CTR value needs to be set to 0020.

13 - Setting the Voltage Transformer Ratio:

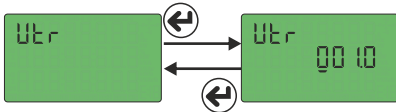

Figure-35

Figure-43

To change the voltage transformer ratio, press the set button while the figure-35 is on the screen. Figure-43 comes to the screen. Press right button to move between digits. Press the down key to change the value of the digit. You can change the digit value which is the underline. When you press the set button after entering the ratio, the voltage transformer ratio is recorded and the screen shows figure-35. You can scroll through the parameters

in the menu by pressing the right button or you can exit the menu by pressing the Esc key.

Example: Medium voltage [M.V.] = Enter the ratio of the voltage transformer that converts 34.500V to 110V. The ratio (multiplier) is calculated as $34,500 / 110 = 313,6$ voltage transformer ratio. The VTR value must be set to 313.6.

14 - RS485 Remote Communication Settings:

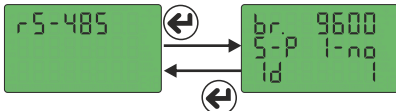

Figure-36

Figure-44

To change the RS-485 remote communication settings, press the set button while figure-36 is on the screen. Figure-44 comes to the screen. Two parameters can be set here. Baudrate (br - communication speed) and Modbus ID (id - the number that identifies the device on the RS 485 line). Press the right button to move the point (.) to the parameter you want to set.

Then change the parameter value by pressing the down key. When you press the Set button, the changes that you made are saved and Figure-36 comes to the screen. You can scroll through the parameters in the menu by pressing the right button or you can exit the menu by pressing the Esc key.

Modbus ID (MBID) value; when more than one communication devices connect to a modem, Serial number or ModBus address must be different. In such cases, enter a different value from other devices.

Baudrate(br): 1200 - 38400 bps, **ModBus ID(id):** 1 - 247 **Stop bits:** 1-2, **Party :** Even, Odd, None.

Note: If the cable length in the RS485 communication line is too high (>100m), connect the 120R resistor parallel to the A-B (RS-485) terminal of the begin and end of the communication line to avoid data loss.

15 - Deleting Energy and Demand Records:

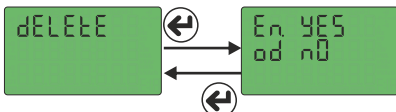

Figure-37

Figure-45

To delete the records, press the set key while figure-37 is on the screen. Figure-45 comes to the screen. You can delete 2 records here. Energy (En) and Demand (dE). Press the right key to move the point (.) to the record which you want to delete. Then press the down key to change the value to "yes". The record value which you do not want to delete must remain in "no".

When you press the Set button, only records with the value "yes" will be deleted and the Figure-37 comes to the screen. You can scroll through the parameters in the menu by pressing the right button or you can exit the menu by pressing the Esc key.

16- Enter Password Value:

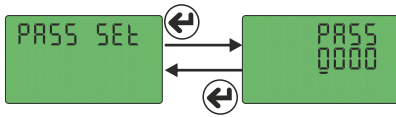

Figure-38

Figure-46

In order to change password; press set button while Figure-38 is on the screen. The Figure-46 comes to the screen. In order to pass through steps; press the button on the right. In order to change the value of the step press the "down" button. You can change the step value with underline. If you press the set key after entering the password, the password is saved and the screen comes in figure-38. Pressing the right key; you can pass through the parameters in the menu or pressing "Esc" key; you can quit the menu.

you can pass through the parameters in the menu

17- Adjusting the Backlight Duration:

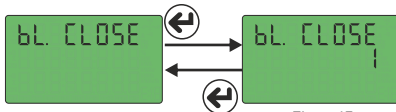

Figure-39

Figur-47

In order to adjust the backlight duration (after the set time, the screen light turns off until any button is pressed to save power); press set button while Figure-39 is on the screen. The Figure-47 comes to the screen. Press the right button to increase the value. If you press the set key after adjusting the backlight duration (min.), the value is saved and the screen comes in figure-39. Pressing the right key; you can pass through the parameters in the menu or pressing "Esc" key; you can quit the menu.

18 - Assigning Tasks to Relay1 and Relay2:

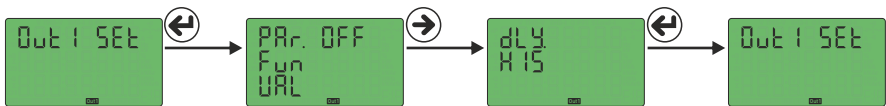

Figure-40

Figure-48

Figure-49

Figure-40

To assign the task to relay 1, press the set key, when figure-40 is on the screen. The Figure-48 comes to the screen. There are 5 settings; these are Parameter (Par), Function (Fun), Value (VAL), Delay Time (dLY) and Hysteresis Value (HIS). Press the right key to move the point (.) to the parameter. Press the down key to bring up the desired parameter. Then press the right key to move the point (.) to the function. Press the down key to set the function to low or high set. Press the right key to move the point (.) to value. Press the down key to enter the desired value. Press the right key to move the point (.) to waiting time. (Figure-49) Press the down key to enter the desired value. Press the right key to move the point (.) to hysteresis value. Press the down key to enter the desired value. Then when you press the set key, the task will be assigned to relay 1 and Figure-40 comes to screen. You can scroll through the parameters in the menu by pressing the right button or you can exit the menu by pressing the Esc key.

Parameters (Par): Voltage (U_{Ln}), current (I_{Ln}), total current (ILt), total harmonic distortion belong to Voltage ($thdV$), total harmonic distortion belong to Current ($thdI$), power factor (PF), voltage Unbalance (U_{Un}), current Unbalance (I_{Un}), digital input (di_n) and off (OFF).

Function (Fun): Functions to be applied for parameters: if greater than value (hi) and smaller than value (LO).

Value(Val): The value to be set for the parameters.

Delay Time (dLY): When the conditions set for the relay have occurred or disappeared, it is time to wait for the relay to gets energised on or de-energised.

Hysteresis Value (HIS): The tolerance value entered for the set value for relayizing or de-energizing the relay when the condition set for the relay has disappeared.

Example: High voltage is 250V and hysteresis value is 5V. When 250V voltage is applied to the device, the device will enter into to error. The voltage will have to drop to 245V to get out of the error.
(High Voltage Set Value - Hysteresis Value)

Note1: The task assignment of relay 2 is assigned in the same way as relay 1. While in menu for relay 2 assignment. The entrance should be done from the figure-42.

Note2: To use the digital input parameter, 9V-24DC energy should be applied from the entrance of input to the device. In these parameters if the relay is wanted to be pulled HI function; or if it is wanted to be pulled while the energy is not available LO function should be chosen. The change of the voltage at the data input should be minimum at one second (1Hz)

Example: If the voltage value exceeds 250V, the relay 1 gets energised after 5 seconds. De-energised after 5 seconds when voltage value falling to 245.

Parameter (PAR) = ULn, function (fun) = hl, value (VAL) = 250V, delay time (dLY) = 5 seconds and hysteresis value (HIS) = 5V should be set. If the relay is set in this way, the relay 1 is gets energised after 5 seconds when the voltage rises above 250V. When the voltage drops to 245V, the relay is de-energised after 5 seconds.

19 - Menu Values Table:

Parameter Number	Parameter	Unit	Factory Value	Minimum Value	Maximum Value
Ctr	Current Transformer Ratio	-	1	1	5000
Vtr	Voltage Transformer Ratio	-	1.0	0.1	999.0
br	Baudrate	bps	9600	1200	19200
-	Stop bits	-	1	1	2
-	Data bits	-	8	-	-
-	Parity	-	none	None, Even, Odd	-
Id	ModBus ID	-	1	1	247
En	Deleting Total Energy	-	No	Yes	No
dE	Deleting Demand Values	-	No	Yes	No
PASS	Password	-	0	0	9999
bL. CLOSE	Backlight Duration	minute	1	Off	60
Par	Parameter	-	OFF	OFF, ULn, lIn, lIt, thdU, thdI, PF, U Un, I Un, dl n	-
Fun	Function	-	High	Low	High
UAL	Uln [voltage]	Volt	vtr x 10	vtr x 10	vtr x 500
	lIn [Current]	Amper	{ctrx10}/100	{ctrx10}/100	{ctrx500}/100
	lIt [Total Current]	Amper	{ctrx3x10}/100	{ctrx3x10}/100	{ctrx3x500}/100
	thdU [Total Voltage Har.]	%	1	1	50
	thdI [Total Current Har.]	%	1	1	50
	PF [Power Factor]	%	0.50	0.50	0.99
	U Un [Voltage imbalance]	%	1	1	50
	I Un [Current Imbalance]	%	1	1	50
dLY	Delay Time	second	0	1	1000
HIS	Hysteresis Value	Volt, Amper, %	0	1	10

20- Dimensions:

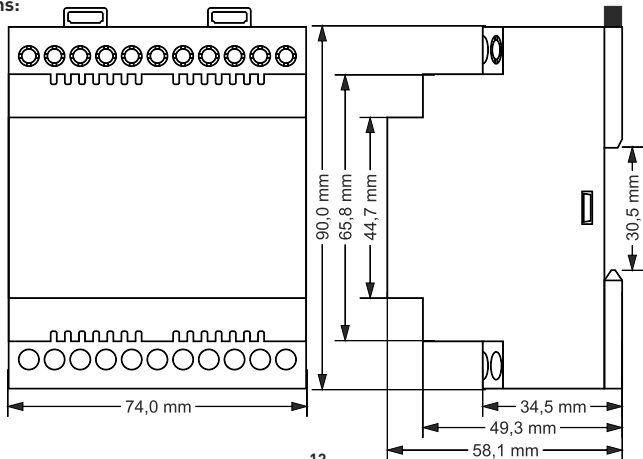

21 - Technical Specifications:

Operating Voltage	85V - 240V AC
Operating Frequency	50 / 60 Hz
Operating Power	<10VA
Operating Temperature	-20°C.....55°C
Voltage Inputs	5V -330V AC
Voltage Meas. Range	5V - 330kV
Current Input	10mA - 5.5A
Current Meas. Range	10mA - 5.500A
Voltage, Current Accuracy	%±0.5
Active Energy Accuracy	%±1
Reactive Energy Accuracy	%±2
Supported Connection	3P4W
Current Transformer Ratio	1....1000
Voltage Transformer Ratio	1,0....999,9
Harmonic Voltage Meas.	3 - 31
Harmonic Current Meas.	3 - 31
Communication	RS485 MODBUS RTU
Baudrate	1200bps - 19200bps
Stop Bit	1 or 2
Parity	None, Even, Odd
Display	53 x 31mm Glass LCD
Relay Output	2x 3A/250VAC (Resistive Load)
Digital Input	1x 9V - 24VDC
Weight	<300Gr.
Protection Class	IP20
Panel Hole Sizes	91mm x 91mm
Connection Type	Plug-in terminal connection
Cable Diameter	1,5mm²
Mounting	Front panel mountings
Operating Altitude	<2000meters

22 - Index:

Subject:	Page
1 - Connection Diagrams:	1
2 - Matters to be considered in current transformer selection and connection:	2
3 - Warnings:	2
4 - Device Maintenance:	2
5 - General:	2
6 - First Operation of the Device:	2
7 - Screen Presentation:	3
8 - Button Presentation:	4
9 - Progress on Screen Information:	5
10 - Fast Progress on Screen Information:	8
11 - Menu Structure:	9
12 - Set up the Current Transformer Ratio :	10
13 - Set up the Voltage Transformer Ratio :	10
14 - Remote Communication Settings of RS485:	10
15 - Delete Energy and Demand Records:	10
16 - Enter Password Value:	11
17 - Adjusting the Backlight Duration:	11
18 - Assigning Tasks to Relay1 and Relay2:	11
19 - Menu Values Table:	12
20 - Dimensions:	12
21 - Technical Specifications:	13
22 - Index:	13
23 - Contact Information:	13

23 - Contact Information:

Muratpaşa Mah. Uluyol Cad.
İskent Sanayi Sitesi, E-Blok, 1.Kat
BAYRAMPAŞA / İSTANBUL / TÜRKİYE
Tel: 0212 578 04 38 - 48 | Fax: 0212 578 04 36
www.tense.com.tr | info@tense.com.tr



Energy and
Compensation
Tracking System
www.tenseenerji.com